



Maximizing the impact of innovative energy approaches in the EU islands

# INSULAE Project

Sustainable Places 2022

9th September - Nice, FR

Bruno Sodiro, Rina Consulting



**SUSTAINABLE  
PLACES**



This project has received funding from the European Union's Horizon 2020 research and innovation programme under Grant Agreement No 824433.

# 1 – Project overview

# 1- Project info

- ✓ H2020-LC-SC3-2018-ES-SCC Call
- ✓ Innovation Action
- ✓ Total Cost 12.160.234,50 €
- ✓ Duration 48M + 8M (extension)
- ✓ Coordinator CIRCE
- ✓ 26 partners from 9 EU countries



**CERTH**  
CENTRE FOR RESEARCH & TECHNOLOGY HELLAS



# 1- Objectives, concept and expected outcome

**Goal:** Deployment of innovative solutions aiming to the **EU islands decarbonization**

**Scope:** Development and demonstration at **3 Lighthouse Islands** of a set of interventions linked to **7 replicable use cases**, whose results will validate an **Investment Planning Tool** that will be then demonstrated at **4 Follower Islands** for the development of **their associated Action Plans**.

## Lighthouse islands



Project directly considers the legal and regulatory framework of **57%** of the population living in EU islands

## Follower islands

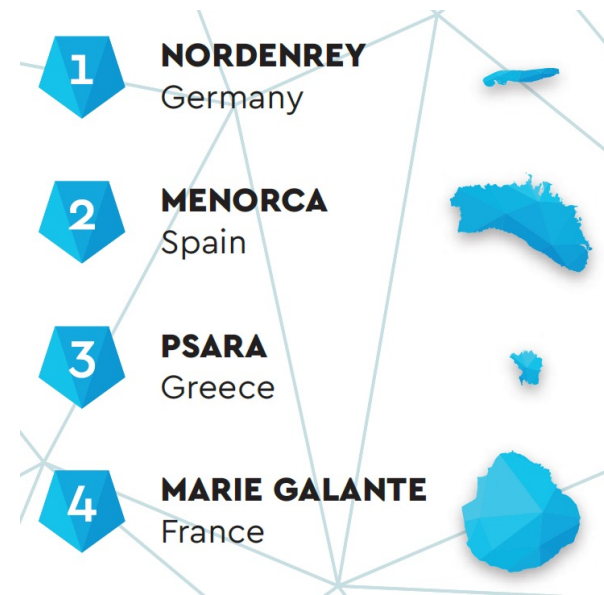

# 1- Demonstration use cases and pilots

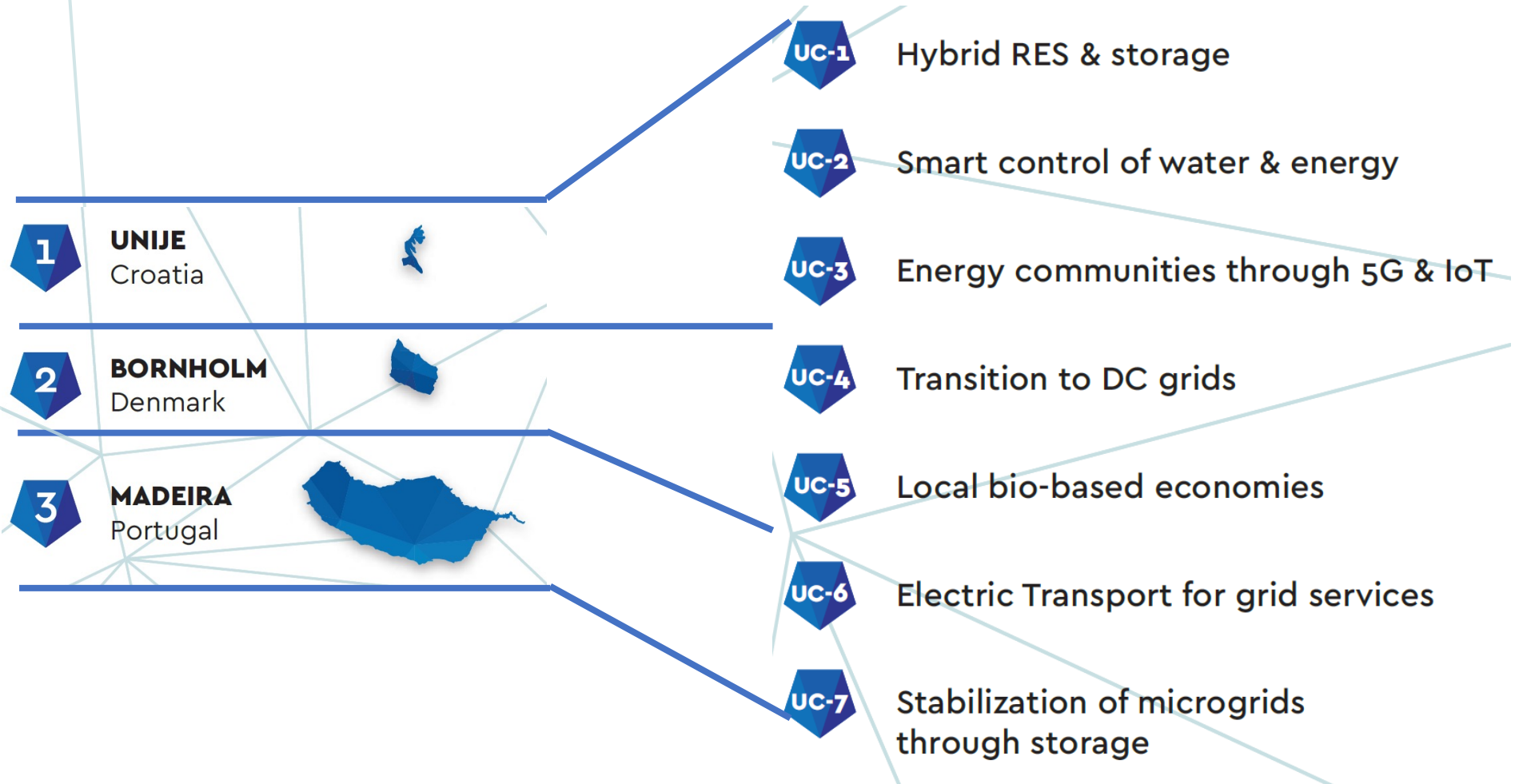

## 2 – Lighthouses

# 2-Unije : Innovation cases

## UC1 – Hybrid RES and storage

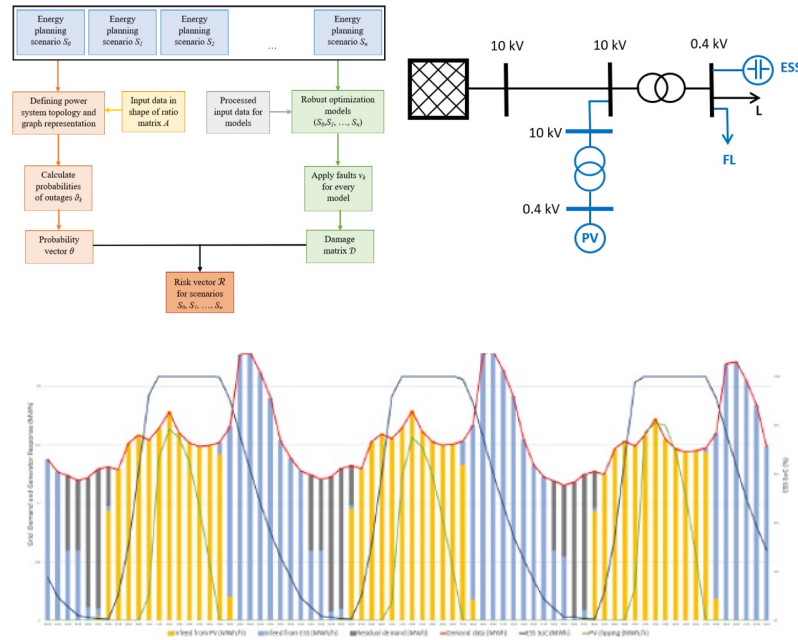

## UC2 – Smart control of Water & Energy

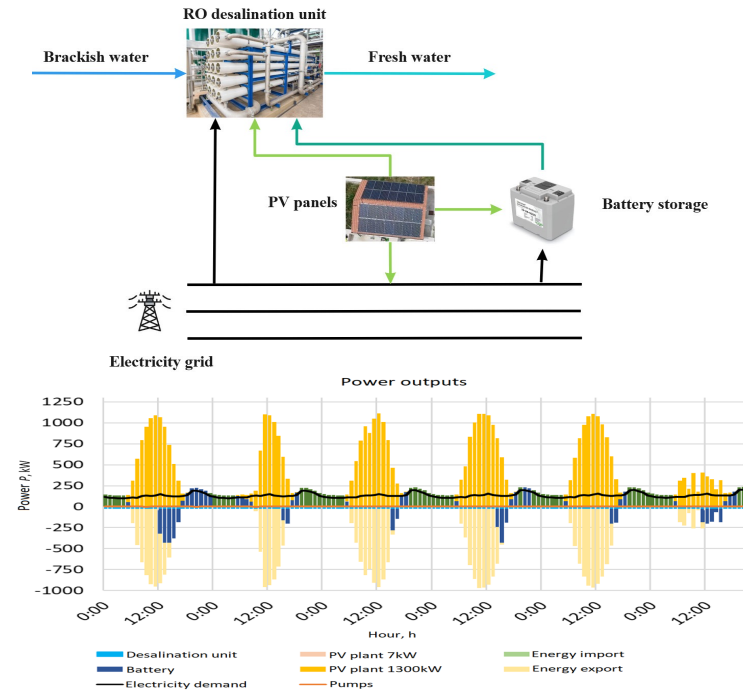

## UC3 – EC through 5G&IoT

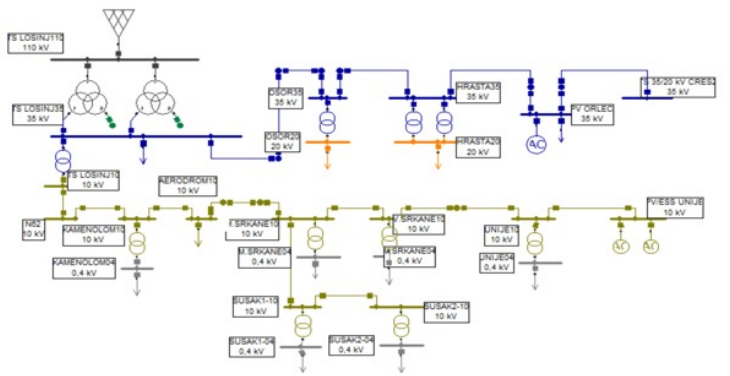
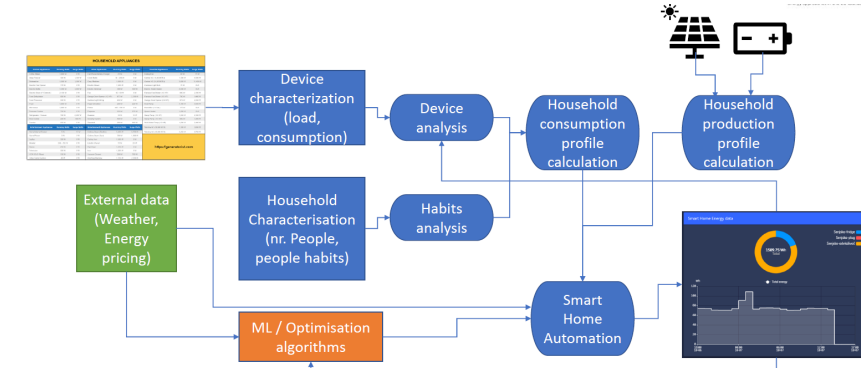

# 2-Bornholm: Innovation cases

## UC 4 – DC microgrid

Development, deployment, commissioning and demonstration of a battery-buffered solar PV-powered ultra-fast EV charging station.

- system up and running from 6/2021.
- EV charging is free-of-charge.
- > 300 EV charging events
- Collection of valuable historical EV charging and solar PV production data for almost a year.

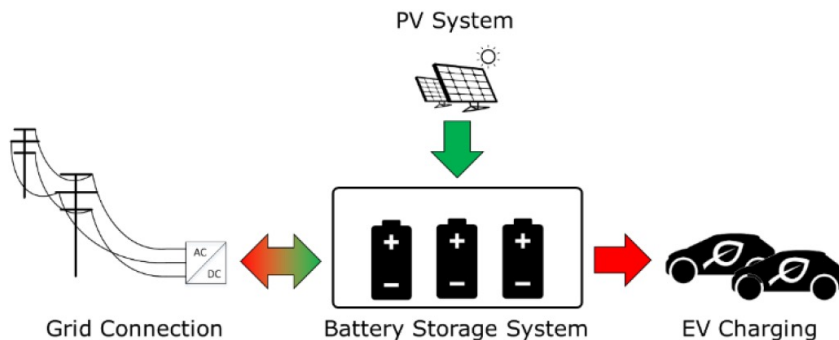

## UC 5 – Virtual Power Plant (VPP)

Analytical and experimental investigation of the potential for flexibility provision to the Bornholm's power system and bio-fuel production by a multi-domain RES-based VPP.

Site experiments on the active power control of :

- a biogas plant
- solar parks
- wind turbines

supported by extensive modelling and simulation studies.

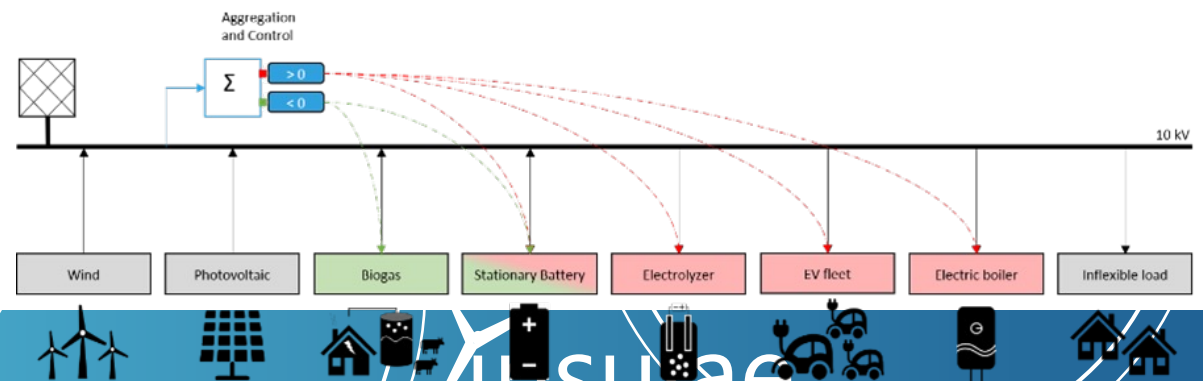



# 2-Madeira: Innovations

## UC 6 – Electric transport for grid services

Two 50 kW quick chargers and one fully SiC 50 kW fast charger, all of them integrating new functionalities for frequency support and voltage regulation and a control system will be developed to manage all the charging infrastructure in an integrated way.

## UC 7 – stabilization of weak microgrids through energy storage

A 100 kW/100KWh storage system integrated to provide ancillary services to a weak microgrid relying on a inverter and controller with embedded algorithms allowing for grid stabilization and operation in islanding mode. .

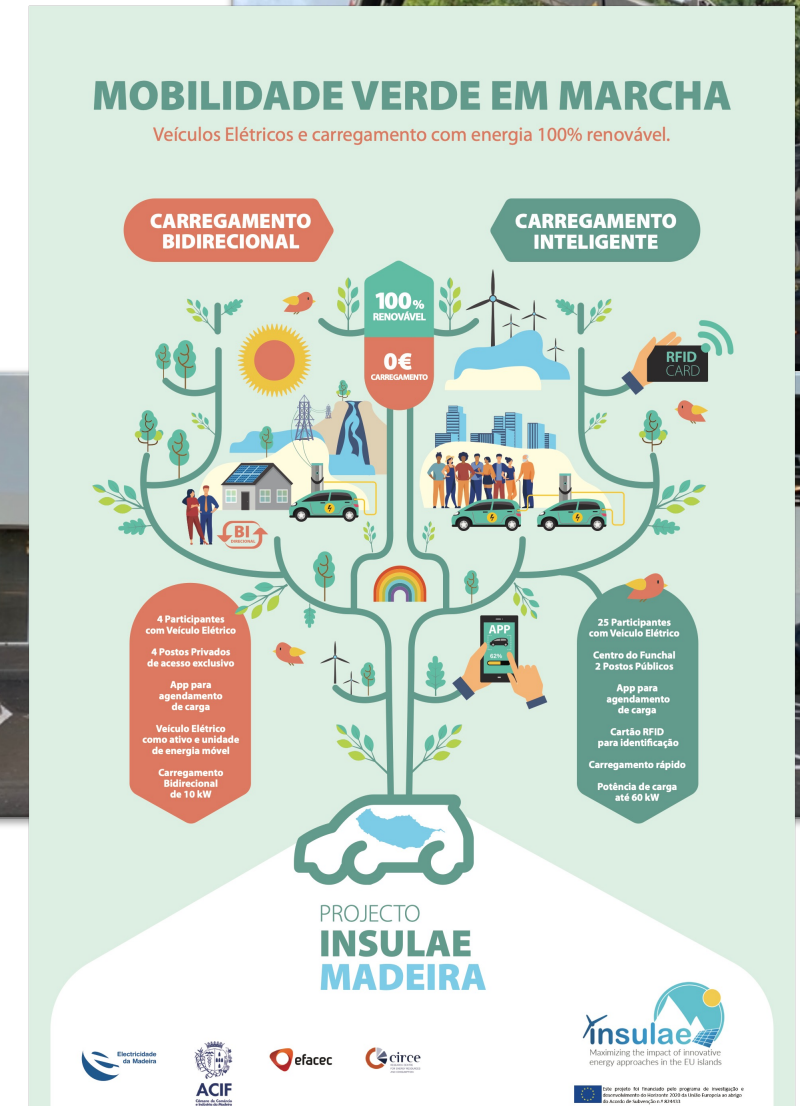

# 3 – The IPT

## Investment Planning Tool

# 3. What is the Investment Planning Tool ?

- The Investment Planning Tool (IPT) is a web-based software which objective is to assist island decision-makers to design energy strategies, and to monitor their impacts on insular energy systems.
- The IPT is divided in two modules:
  - The **Island Modelling Assistant (IMA)**
    - This module is used to represent the **current state of the island energy system**.
  - The **Scenarisation Module**:
    - This module is used to represent **possible futures of the island energy system**, and to investigate the potential benefits of different actions that could be implemented by policy-makers.

# 3 – Investment Planning Tool

## ✓ **Model the multi-energy system** of an island:

- ✓ Detailed representation of the different energy vectors (electricity, heat, gas, petroleum products imports, etc.);
- ✓ Representation of the energy flows within the island, and import/export with the mainland;
- ✓ Hourly optimization of the demand-supply equilibrium in order to minimize the total generation costs.

## ✓ **Advanced features** to explore the possible futures of the island energy system:

- ✓ The IPT includes a **library of “interventions”** (development of electric vehicles, new power interconnection with the mainland, etc.) to create contrasted pathways of evolution;
- ✓ Possibility to **optimize the investments in power generation capacities** in order to reach a specific **policy target** (minimum share of renewable, carbon neutrality);
- ✓ Possibility to model the evolution for a single year, or for a full pathway to capture possible bottlenecks at intermediate years.

## ✓ **Analyze the results with Key Performance Indicators (KPIs)** at different scales

- ✓ **Display indicators on a map** to easily compare different areas of the island;
- ✓ Use hourly temporal indicators for advanced analysis of supply-demand equilibrium;
- ✓ **Use aggregated values** to summarize information, and compare different pathways of evolution for the whole island.

# 3 – Investment Planning Tool

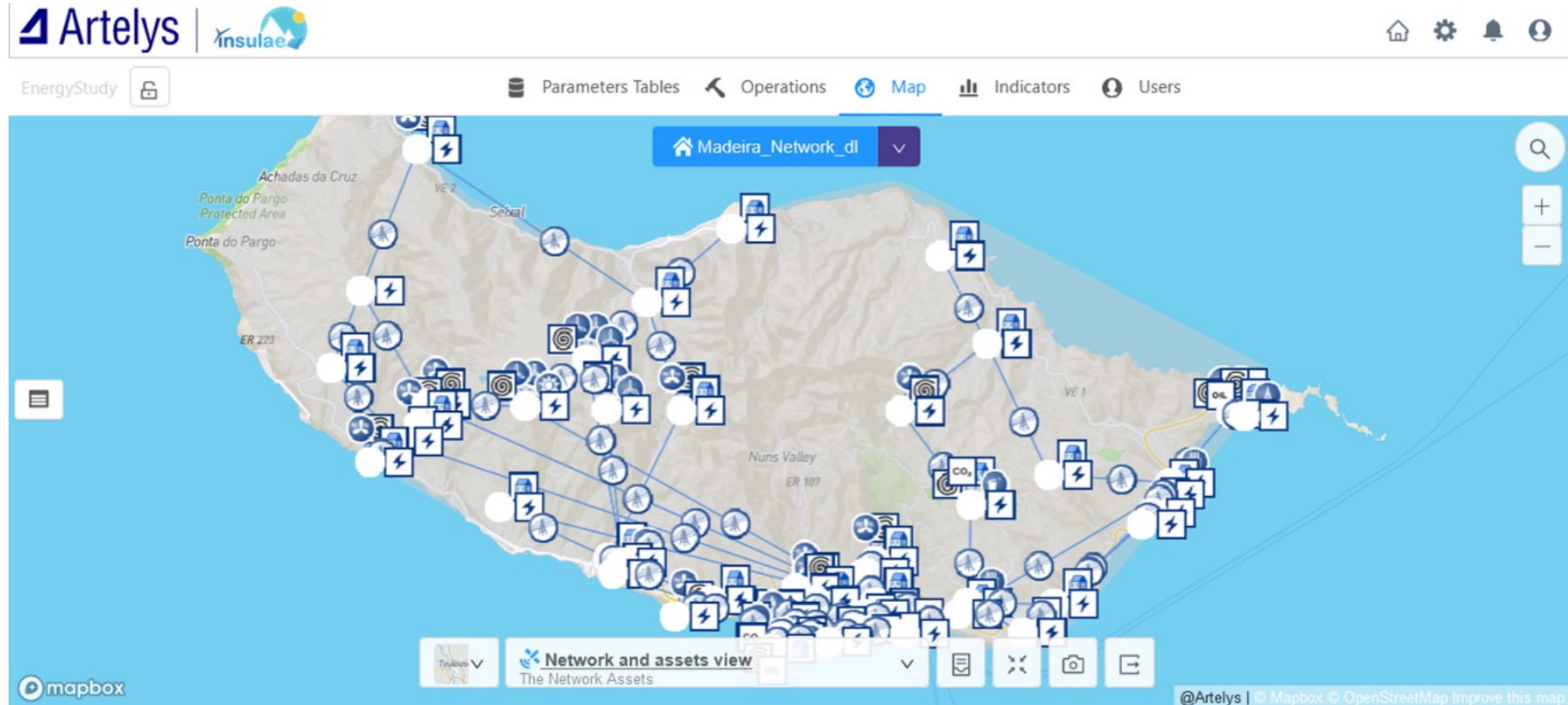

Representation of the current power system of Madeira Island in the IPT

# 3. Investment Planning Tool : Scenarisation

## Initialization



Create a study and import the current state of the Island

## Create a pathway



Create a pathway by defining :

- the number of years of the pathway;
- the duration of each step

## Apply interventions



- Create and configure interventions;
- Apply the interventions

## Launch computation



Optimize the generation mix and investment in new generation plants of the different energy pathways.

## Analyze results



Analyze the results of your simulation and compare the pathway thanks to the different KPIs.

# 3 – Investment Planning Tool

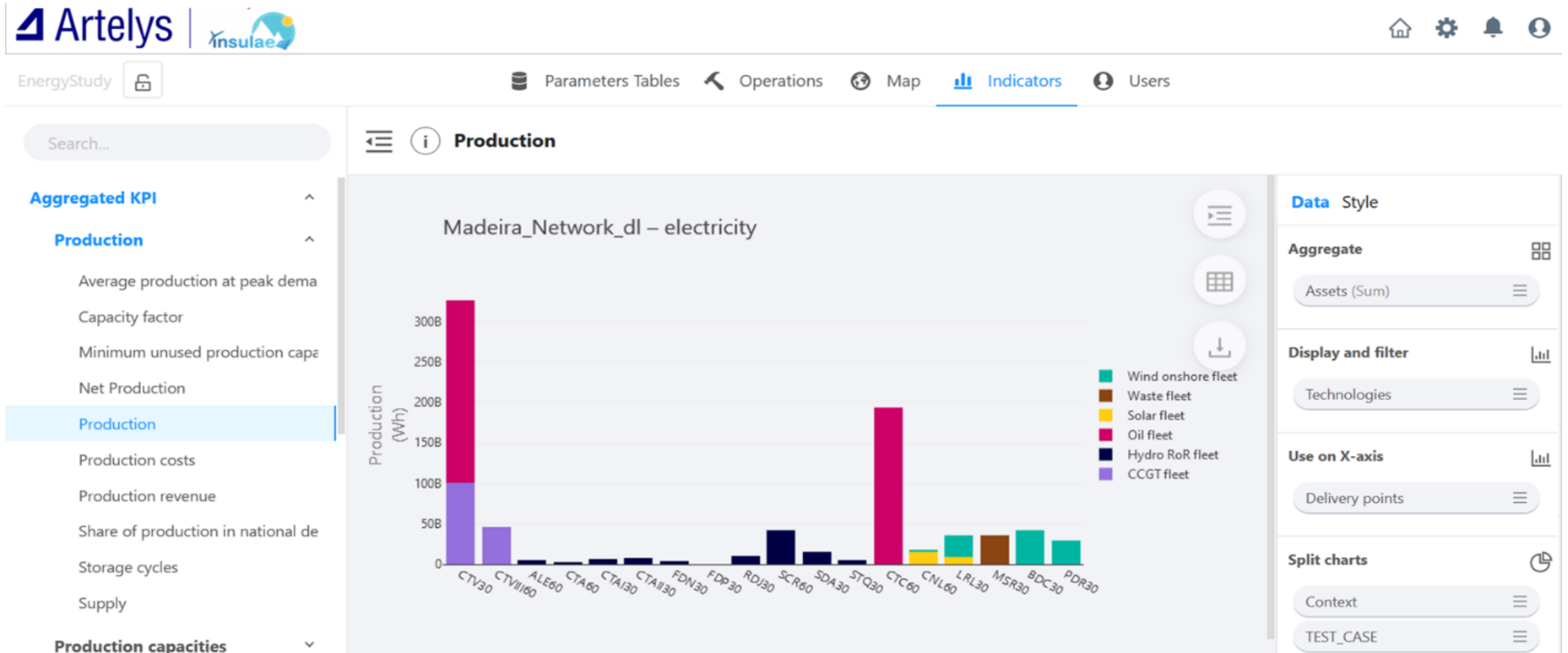

Representation of the power production for each substation of Madeira Island in the KPI view of the IPT

# 4 – Replication



## 4 - Demonstration and Training sessions for the IPT

### Who is going to use IPT and why?

- **IPT can be and should be** used by: municipalities, governmental energy planners, NGOs, universities and research institutes, energy agencies, utilities, private and public companies and private individuals
- **IPT can be and should be** used for:  
The evaluation of Future energy demand and solutions assessments
- For the drafting of SECAPs and CETAs
- Can reveal the Potential Benefits of Interconnection

- In the context of INSULAE, IPT Demonstrations and Trainings are going to be organized for the **EU islands' stakeholders**.

If you think that IPT can serve your purposes, join us to keep you informed about our future demonstration activities!

[ec.europa.eu/eusurvey/runner/insulaeIPT](https://ec.europa.eu/eusurvey/runner/insulaeIPT)

or for short

[bit.ly/insulaeIPT](https://bit.ly/insulaeIPT)



# Thank you !



<http://insulae-h2020.eu/>



[H2020 Insulae Project](#)



[@insulaeproject](#)



[@INSULAE\\_H2020](#)

insulae  
Maximizing the impact of innovative  
energy approaches in the EU islands

